

Lever Pin N Lift

This tool has been developed to safely lift and place G.E.T. such as cutting edges, corner tips etc, from large earthmoving equipment.



Australia Patent No. 2011284782, Canada Patent No. 2805775, Chile Patent No. 259-2013, China Patent No. 201180043686.7,
South Africa Patent No. 2013/00526, US Patent No. 8814240

Trilift® Lever Pin N Lift

We all know that safety in the mining industry is paramount and as such the old methods of removing vehicle components is no longer adequate. Maintenance staff no longer have to use the unsafe 'traditional' methods (welding on a temporary washer or using a magnet) to lift heavy and sharp cutting edges.

The Lever Pin N Lift comes in a durable PVC carry case with moulded high density foam to house each individual component.

Complementing our current range of G.E.T. lifting tools, the design allows for the lifting of cutting edges with square or round holes, and the reversible double countersunk cutting edges.

Each Trilift® Lever Pin N Lift is supplied with adaptors for different size cutting edges. With these adaptors each Trilift® Lever Pin N Lift can be easily adapted to different size holes;

Lever Pin N Lift Model 1622 (Part No. TL20071)

- 16mm
- 18mm with adaptor
- 20mm with adaptor
- 22mm with adaptor

Lever Pin N Lift Model 2538 (Part No. TL20041)

- 25mm
- 32mm with adaptor
- 36mm with adaptor
- 38mm with adaptor

The Lever Pin N Lift supersedes the Slide N Lift products.



What our customers said when asked about the Trilift® Lever Pin N Lift:

Newmont: Twin Creeks Mine Shop Foreman Andy Latham said "If it works anything like the Slide N Lifts we would want to outfit all of our trucks with one."



Steps to rotate a cutting edge

STEP 1

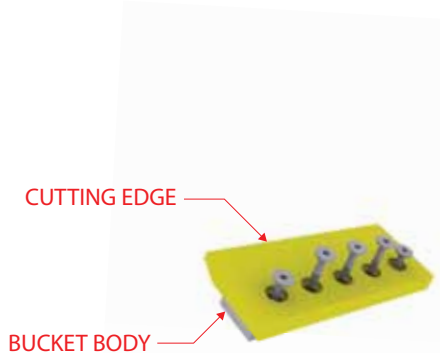

Remove all bolts except two to hold the cutting edge.
Loosen the two end bolts to allow the cutting edge to come away from the bucket body (do not completely remove).

STEP 2

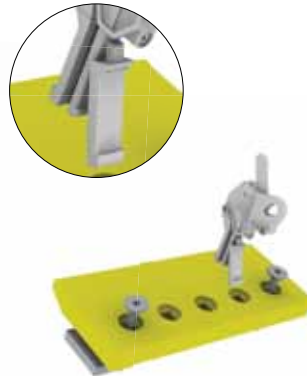

Assemble the appropriate size slippers to the Lever Pin N Lift device to suit the hole in the cutting edge.

STEP 3

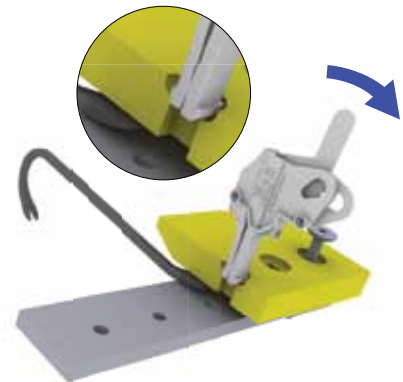

Use a crowbar to lift the cutting edge away from the bucket body.
Draw the handle toward you and insert the Lever Pin N Lift into a hole in the center of the cutting edge.

STEP 4

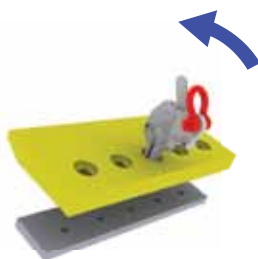

Push the handle away from you to lock the Lever Pin N Lift in place, aligning the lifting eyes.
Attach an appropriate sized d-shackle through the lifting eyes and connect to a chain from an overhead crane or forklift.
Lift the cutting edge a little so that the Lever Pin N Lift is holding its weight and remove the two end bolts.

STEP 5



Lift the cutting edge away and allow it to tilt forward.



Carefully rotate the cutting edge 180 degrees so the holes are now along the top edge.
Re-fit the cutting edge to the bucket body by reversing these steps.

At Hedweld we have a vision that all workshop bays are being used efficiently, utilising specialised tooling that is purpose built for component handling, with the ultimate outcomes of:

minimising workplace injuries and maximising availability.

Specifications

The Trilift® Lever Pin N Lift is compliant with the following standards:

- AS3990-1993 Mechanical equipment-steelwork
- AS 1418.1-2002 Cranes, hoists and winches
- AS/NZS 1252 High strength steel bolts with associated nuts and washers for structural engineering

Features and Benefits

- Eliminates manual handling
- Comes with adaptors for different size cutting edges
- Stainless steel construction
- Use with overhead or mobile crane
- Increase safety for maintenance personnel handling cutting edges/corner tips etc

1622 Key Operating Data & Dimensions

Working Load Limit	250 kg	551 lbs
Tare weight	1.3 kg	2.8 lbs

A	93mm	3.6in
B	32mm	1.2in
C	150mm	4.1in
D	273mm	9.3in
E	16mm	0.6in
	18mm Adaptors	0.7in
	20mm Adaptors	0.78in
	22mm Adaptors	0.86in

2538 Key Operating Data & Dimensions

Working Load Limit	400 kg	880 lbs
Tare weight	4.04 kg	8.9 lbs

A	93mm	3.6in
B	32mm	1.2in
C	150mm	4.1in
D	273mm	9.3in
E	25mm	0.9in
	32mm Adaptors	1.2in
	36mm Adaptors	1.4in
	38mm Adaptors	1.5in

See this innovation in action on

<http://www.hedweld.com.au/trilift/get-products/lever-pin-n-lift>

or [youtube.com](https://www.youtube.com) - search for Lever Pin N Lift

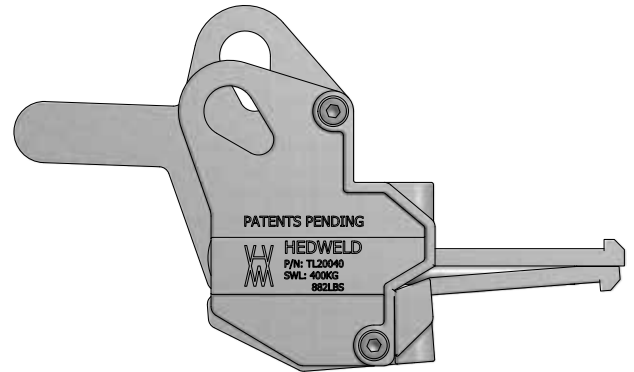

CLOSED DETAIL

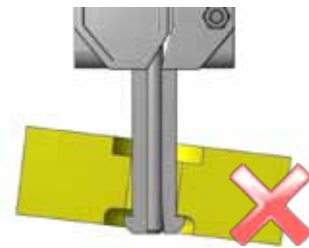
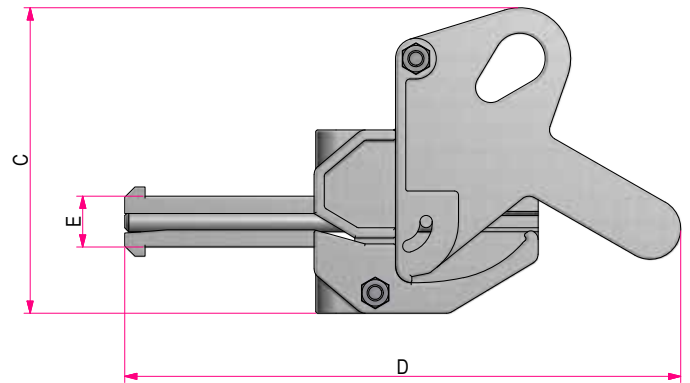
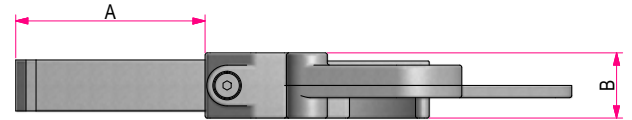

The Trilift® Lever Pin N Lift tool must never be used if the square hole has become rounded, misshapen or is not within the tolerance of $-0/+2.5$ mm ($-0/+0.1$ ") of the relevant nominal size (16, 18, 20, 22, 25, 32, 36 and 38 mm).